

HP T750 G2, HP T750J, HP T1000 G3,
HP T1000J, HP T1500 G3, and
HP T1500J UPS Models
User Guide



© Copyright 2009 Hewlett-Packard Development Company, L.P.

The information contained herein is subject to change without notice. The only warranties for HP products and services are set forth in the express warranty statements accompanying such products and services. Nothing herein should be construed as constituting an additional warranty. HP shall not be liable for technical or editorial errors or omissions contained herein.

Audience assumptions

This guide is for the person who operates, configures, maintains, and troubleshoots UPSs. HP assumes you are qualified in the servicing of high-voltage equipment and trained in recognizing hazards in products with hazardous energy levels.

Special Symbols

The following are examples of symbols used on the UPS to alert you to important information:



RISK OF ELECTRIC SHOCK - Observe the warning associated with the risk of electric shock symbol.



CAUTION: REFER TO OPERATOR'S MANUAL - Refer to your operator's manual for additional information, such as important operating and maintenance instructions.



RJ-45 RECEPTACLE - For 230V units only: This receptacle provides network interface connections. Do not plug telephone or telecommunications equipment into this receptacle.



LOAD ON/OFF - Press the button with this symbol to energize the output receptacles (⎓ indicator illuminates) or to de-energize the output receptacles (⎓ indicator is off).

Regulatory compliance notices

Regulatory compliance identification numbers

For the purpose of regulatory compliance certifications and identification, this product has been assigned a unique regulatory model number. The regulatory model number can be found on the product nameplate label, along with all required approval markings and information. When requesting compliance information for this product, always refer to this regulatory model number. The regulatory model number is not the marketing name or model number of the product.

Federal Communications Commission notice

Class B equipment

This equipment has been tested and found to comply with the limits for a Class B digital device, pursuant to Part 15 of the FCC Rules. These limits are designed to provide reasonable protection against harmful interference in a residential installation. This equipment generates, uses, and can radiate radio frequency energy and, if not installed and used in accordance with the instructions, may cause harmful interference to radio communications. However, there is no guarantee that interference will not occur in a particular installation. If this equipment does cause harmful interference to radio or television reception, which can be determined by turning the equipment off and on, the user is encouraged to try to correct the interference by one or more of the following measures:

- Reorient or relocate the receiving antenna.
- Increase the separation between the equipment and receiver.
- Connect the equipment into an outlet on a circuit that is different from that to which the receiver is connected.
- Consult the dealer or an experienced radio or television technician for help.

Declaration of conformity for products marked with the FCC logo, United States only

This device complies with Part 15 of the FCC Rules. Operation is subject to the following two conditions: (1) this device may not cause harmful interference, and (2) this device must accept any interference received, including interference that may cause undesired operation.

For questions regarding this product, contact us by mail or telephone:

- Hewlett-Packard Company
P. O. Box 692000, Mail Stop 530113
Houston, Texas 77269-2000
- 1-800-HP-INVENT (1-800-474-6836). (For continuous quality improvement, calls may be recorded or monitored.)

For questions regarding this FCC declaration, contact us by mail or telephone:

- Hewlett-Packard Company
P. O. Box 692000, Mail Stop 510101
Houston, Texas 77269-2000
- 1-281-514-3333

To identify this product, refer to the part, series, or model number found on the product.

Modifications

The FCC requires the user to be notified that any changes or modifications made to this device that are not expressly approved by Hewlett-Packard Company may void the user's authority to operate the equipment.

Cables

Connections to this device must be made with shielded cables with metallic RFI/EMI connector hoods in order to maintain compliance with FCC Rules and Regulations.

Canadian notice (Avis Canadien)

Class B equipment

This Class B digital apparatus meets all requirements of the Canadian Interference-Causing Equipment Regulations.

Cet appareil numérique de la classe B respecte toutes les exigences du Règlement sur le matériel brouilleur du Canada.

European Union regulatory notice

This product complies with the following EU Directives:

- Low Voltage Directive 2006/95/EC
- EMC Directive 2004/108/EC

Compliance with these directives implies conformity to applicable harmonized European standards (European Norms) which are listed on the EU Declaration of Conformity issued by Hewlett-Packard for this product or product family.

This compliance is indicated by the following conformity marking placed on the product:



This marking is valid for non-Telecom products and EU harmonized Telecom products (e.g. Bluetooth).



This marking is valid for EU non-harmonized Telecom products.

*Notified body number (used only if applicable—refer to the product label)

Hewlett-Packard GmbH, HQ-TRE, Herrenberger Strasse 140, 71034 Boeblingen, Germany



This symbol on the product or on its packaging indicates that this product must not be disposed of with your other household waste. Instead, it is your responsibility to dispose of your waste equipment by handing it over to a designated collection point for the recycling of waste electrical and electronic equipment. The separate collection and recycling of your waste equipment at the time of disposal will help to conserve natural resources and ensure that it is recycled in a manner that protects human health and the environment. For more information about where you can drop off your waste equipment for recycling, please contact your local city office, your household waste disposal service or the shop where you purchased the product.

Japanese notice

この装置は、クラスB情報技術装置です。この装置は、家庭環境で使用することを目的としていますが、この装置がラジオやテレビジョン受信機に近接して使用されると、受信障害を引き起こすことがあります。取扱説明書に従って正しい取り扱いをして下さい。VCCI-B

Battery replacement notice



WARNING: Power products contain sealed lead-acid battery modules. A risk of fire and burns exists if the battery is not properly handled. To reduce the risk of personal injury:

- Do not attempt to recharge the battery.
- Do not expose the battery to temperatures higher than 60°C (140°F).
- Do not disassemble, crush, puncture, short external contacts, or dispose of in fire or water. The battery might explode.



Batteries, battery packs, and accumulators should not be disposed of together with the general household waste. To forward them to recycling or proper disposal, use the public collection system or return them to HP, an authorized HP Partner, or their agents.

For more information about battery replacement or proper disposal, contact an authorized reseller or an authorized service provider.

Power cord statement for Japan

製品には、同梱された電源コードをお使い下さい。
同梱された電源コードは、他の製品では使用出来ません。

Electrostatic discharge

Preventing electrostatic discharge

To prevent damaging the system, be aware of the precautions you need to follow when setting up the system or handling parts. A discharge of static electricity from a finger or other conductor may damage system boards or other static-sensitive devices. This type of damage may reduce the life expectancy of the device.

To prevent electrostatic damage:

- Avoid hand contact by transporting and storing products in static-safe containers.
- Keep electrostatic-sensitive parts in their containers until they arrive at static-free workstations.
- Place parts on a grounded surface before removing them from their containers.
- Avoid touching pins, leads, or circuitry.
- Always be properly grounded when touching a static-sensitive component or assembly.

Grounding methods to prevent electrostatic discharge

Several methods are used for grounding. Use one or more of the following methods when handling or installing electrostatic-sensitive parts:

- Use a wrist strap connected by a ground cord to a grounded workstation or computer chassis. Wrist straps are flexible straps with a minimum of 1 megohm +10 percent resistance in the ground cords. To provide proper ground, wear the strap snug against the skin.
- Use heel straps, toe straps, or boot straps at standing workstations. Wear the straps on both feet when standing on conductive floors or dissipating floor mats.
- Use conductive field service tools.
- Use a portable field service kit with a folding static-dissipating work mat.

If you do not have any of the suggested equipment for proper grounding, have an authorized reseller install the part.

For more information on static electricity or assistance with product installation, contact an authorized reseller.

Table of Contents

1	Introduction	1
2	Safety Warnings	3
3	Installation	4
	Inspecting the Equipment	4
	Connecting the UPS Internal Battery	4
	Installing the UPS	6
	UPS Rear Panels	7
4	Operation	10
	Turning the UPS On	10
	Starting the UPS on Battery	10
	Turning the UPS Off	11
	Standby Mode	11
	UPS Front Panel	11
	Initiating the Self-Test	12
5	Additional UPS Features	13
	Voltage Configuration	13
	Communication Options	14
	USB Port	14
	Serial Port	15
	Network Transient Protector	16
	HP Power Manager Software	16
6	UPS Maintenance	17
	UPS and Battery Care	17
	Transporting the UPS	17
	Storing the UPS and Batteries	18
	UPS Battery Spares	19
	Ordering Spares	19
	UPS Spare Parts List	19
	Replacing Batteries	20
	Testing New Batteries	22
	Recycling the Used Battery or UPS	23
7	Specifications	24
8	Troubleshooting	27
	Audible Alarms and UPS Conditions	27
	Silencing an Audible Alarm	27
	Site Wiring Fault (100–120V Models Only)	27
	Technical Support	29
	Before You Contact HP	29
	HP Contact Information	30
9	Warranty Information	31
	Limited Warranty	31
	\$250,000 Computer Load Protection Guarantee	31
	Pre-Failure Battery Warranty	31

Chapter 1

Introduction

The HP T750 G2, HP T750J, HP T1000 G3, HP T1000J, HP T1500 G3, and HP T1500J Uninterruptible Power System (UPS) models protect your sensitive electronic equipment from basic power problems such as power failures, power sags, power surges, brownouts, and line noise.

Power outages can occur when you least expect them, and power quality can be erratic. These power problems have the potential to corrupt critical data, destroy unsaved work sessions, and damage hardware — causing hours of lost productivity and expensive repairs.

With the HP T750 G2, HP T750J, HP T1000 G3, HP T1000J, HP T1500 G3, and HP T1500J, you can safely eliminate the effects of power disturbances and guard the integrity of your equipment. The UPS's flexibility to handle an array of network devices makes it the perfect choice to protect your LANs, servers, workstations, and other electrical equipment.

Figure 1 shows the HP T750 G2 UPS.

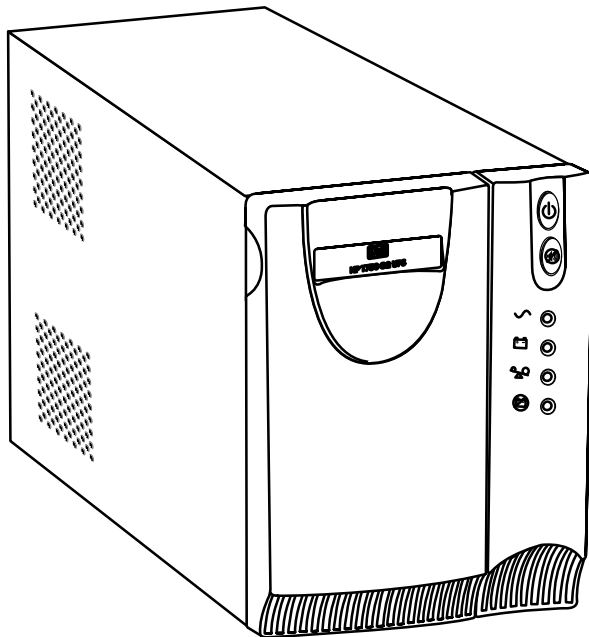

Figure 1 HP T750 G2 UPS

Providing outstanding performance and reliability, the UPS's unique benefits include:

- Buck and Boost voltage regulation that ensures consistent voltage to your load by correcting voltage fluctuations.
- Advanced battery management to increase battery service life, optimize recharge time, and provide a warning before the end of useful battery life.
- Start-on-battery capability for powering up the UPS even if utility power is not available.
- Hot-swappable batteries that simplify maintenance by allowing you to replace batteries safely without powering down the critical load.
- Two standard communication options (USB and serial port).
- Network transient protector that guards your network communications equipment from surges. Low voltage models can also protect modems, fax machines, or other telecommunications equipment.
- Advanced power management with the HP Power Manager software for graceful shutdowns and power monitoring.
- Backed by worldwide agency approvals.

IMPORTANT SAFETY INSTRUCTIONS SAVE THESE INSTRUCTIONS

This manual contains important instructions that you should follow during installation and maintenance of the UPS and batteries. Please read all instructions before operating the equipment and save this manual for future reference.

DANGER



This UPS contains **LETHAL VOLTAGES**. All repairs and service should be performed by **AUTHORIZED SERVICE PERSONNEL ONLY**. There are **NO USER SERVICEABLE PARTS** inside the UPS.

WARNING



- This UPS contains its own energy source (batteries). The output receptacles may carry live voltage even when the UPS is not connected to an AC supply.
- For 220–240V models, the output receptacles may remain electrically live. If the input power source in your application is wired line-to-neutral (as in most European applications), the voltage to the output receptacles is 0V. With line-to-line input wiring, the voltage to the output receptacles is 100–120V (measured from line-to-ground or line-to-neutral, depending on the UPS wiring).
- Do not remove or unplug the input cord when the UPS is turned on. This removes the safety ground from the UPS and the equipment connected to the UPS.
- To reduce the risk of fire or electric shock, install this UPS in a temperature and humidity controlled, indoor environment, free of conductive contaminants. Ambient temperature must not exceed 40°C (104°F). Do not operate near water or excessive humidity (95% maximum).
- To comply with international standards and wiring regulations, the total equipment connected to the output of this UPS must not have an earth leakage current greater than 1.5 milliamperes.

CAUTION



- The wall outlet must be within 2 meters of the equipment and accessible to the operator.
- Batteries can present a risk of electrical shock or burn from high short-circuit current. The following precautions should be observed: 1) Remove watches, rings, or other metal objects; 2) Use tools with insulated handles; 3) Do not lay tools or metal parts on top of batteries; 4) Disconnect charging source prior to connecting or disconnecting battery terminals.
- Proper disposal of batteries is required. Refer to your local codes for disposal requirements.
- Never dispose of batteries in a fire. Batteries may explode when exposed to flame.
- Do not open or mutilate the battery or batteries. Released electrolyte is harmful to the skin and eyes and may be extremely toxic.
- Replace batteries with the same number and type of batteries as originally installed in the UPS.
- If the UPS requires any type of transportation, disconnect the internal UPS batteries before transporting (see page 17).

Chapter 3

Installation

This section explains:

- Equipment inspection
- UPS internal battery connection
- UPS installation
- UPS rear panels

Inspecting the Equipment

If any equipment has been damaged during shipment, keep the shipping cartons and packing materials for the carrier or place of purchase and file a claim for shipping damage. If you discover damage after acceptance, file a claim for concealed damage.

To file a claim for shipping damage or concealed damage: 1) File with the carrier within 15 days of receipt of the equipment; 2) Send a copy of the damage claim within 15 days to your service representative.

NOTE: Check the battery recharge date on the shipping carton label. If the date has passed and the batteries were never recharged, do not use the UPS. Contact your service representative.

Connecting the UPS Internal Battery

To ensure proper battery operation:

- 1 Verify that the UPS power is off and unplugged.
- 2 Pull the top left corner forward and remove the UPS front bezel (see Figure 2).

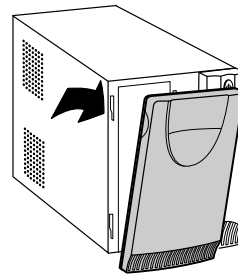

Figure 2 Removing the UPS Front Bezel

- 3 Slide up and remove the metal battery cover (see Figure 3). Do not remove any screws.

NOTE: For HP T750 G2, HP T750J, and HP T1000 G3 models, carefully remove the metal battery cover to avoid damaging the battery disconnect blades.

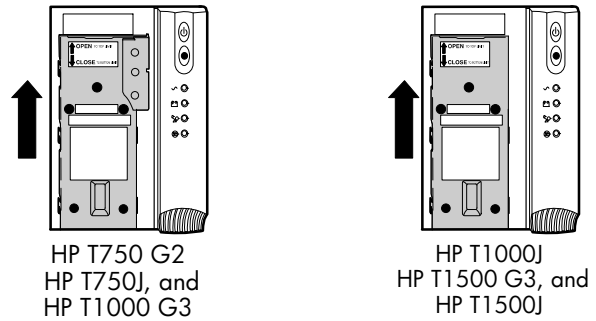

Figure 3 Removing the Battery Cover

- 4 Remove the protective label from the internal battery connector (see Figure 4).

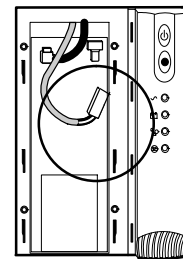

Figure 4 Removing the Protective Label

- 5 Connect the red wire to the positive (+) battery connector (see Figure 5).

NOTE: A small amount of arcing may occur when connecting the batteries. This is normal and does not damage the unit or present any safety concern.

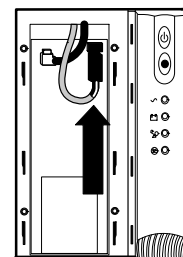

Figure 5 Connecting the Internal Battery Connector

- 6 Replace the metal battery cover.
- 7 Replace the UPS front bezel.

Installing the UPS

NOTE: Do not make unauthorized changes to the UPS or accessories; otherwise, damage may occur to your equipment and void your warranty.

To install the UPS:

- 1 Verify that the DIP switch is set to the correct output voltage and input voltage range (see Table 1 on page 14).
- 2 If you plan to use HP Power Manager software, first connect your computer to the USB port or UPS serial port using the supplied cable. For more information about communication options, see page 14.
- 3 **For 230V models only**, plug the detachable power cord into the input connector on the UPS rear panel.
- 4 Plug the UPS power cord into a power outlet.
- 5 Plug the equipment to be protected into the UPS output receptacles.

NOTE: DO NOT connect laser printers to the UPS because of the exceptionally high power requirements of the heating elements.

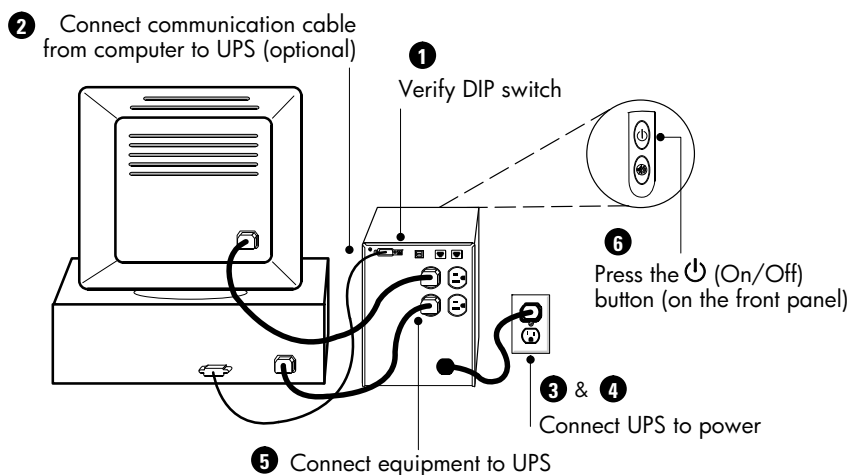



Figure 6 Typical UPS Installation (120V Model Shown)

- 6 Press and hold the  (On/Off) button until you hear the UPS beep.

The  (Power On) indicator illuminates green indicating that power is available to your equipment. The UPS conducts a self-test and enters Normal mode.

If the UPS beeps or a UPS alarm indicator stays on, see Table 10 on page 28.

NOTE: The batteries charge to 90% capacity in approximately 3 hours. However, to fully charge, HP recommends that the batteries charge for 6 to 24 hours after installation or long-term storage.

UPS Rear Panels

This section shows the UPS rear panels.

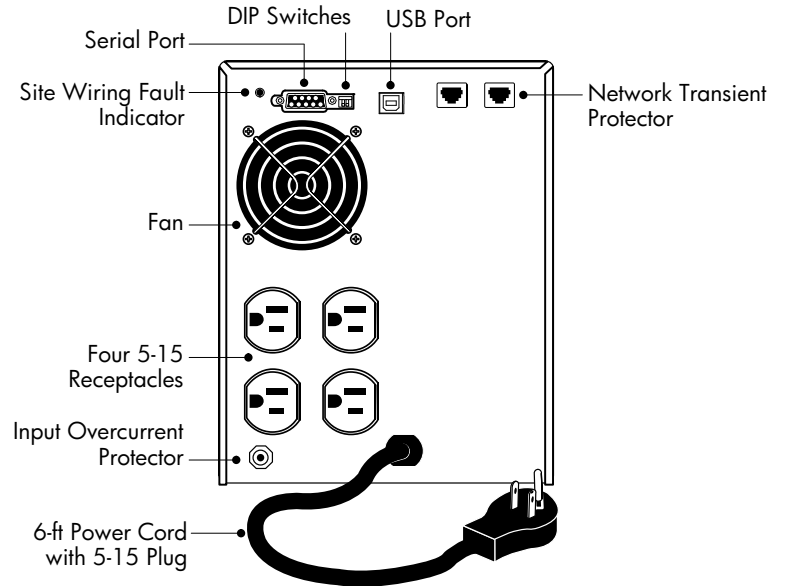

Figure 7 HP T750 G2 120V Rear Panel

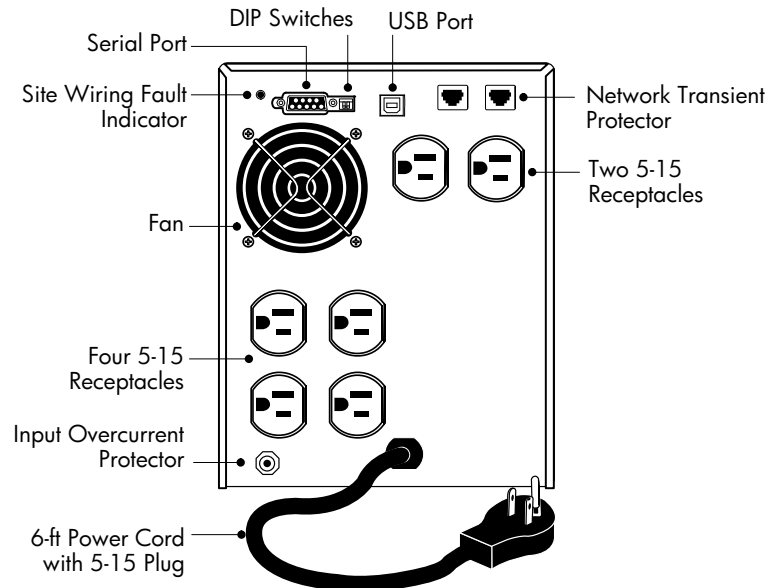

Figure 8 HP T750J 100V and HP T1000 G3 120V Rear Panel

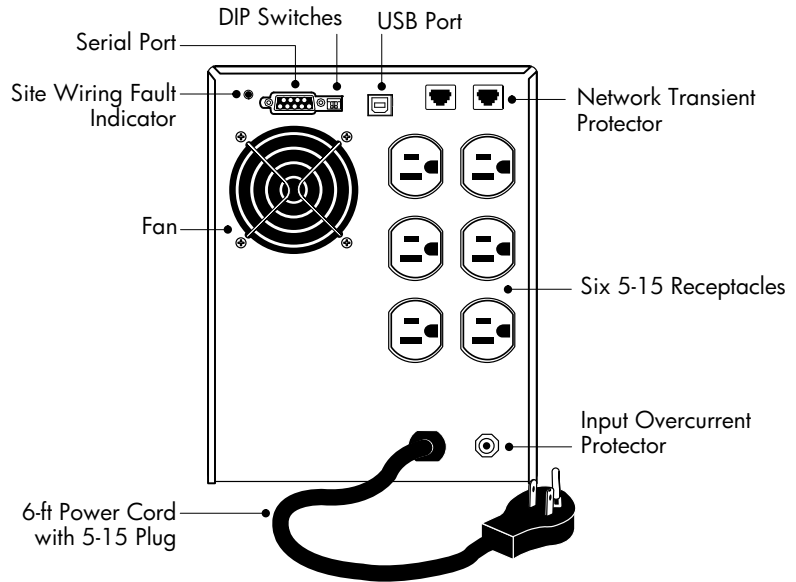

Figure 9 HP T1000J 100V, HP T1500J 100V, and HP T1500 G3 120V Rear Panel

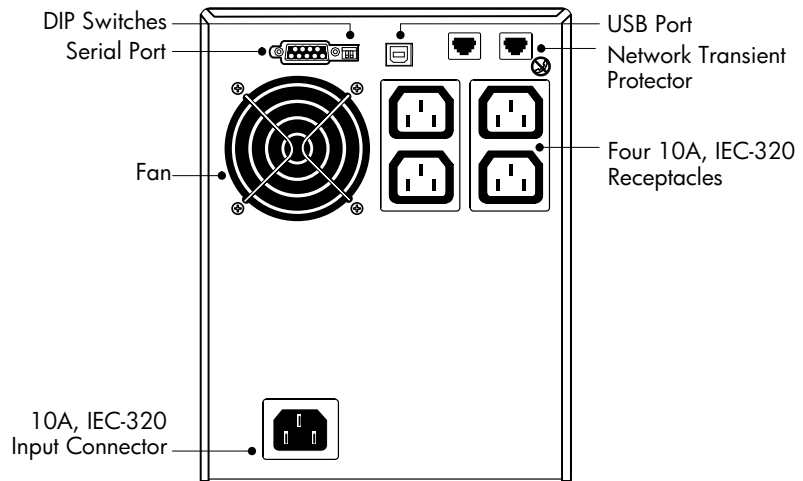

Figure 10 HP T750 G2, 230V Rear Panel

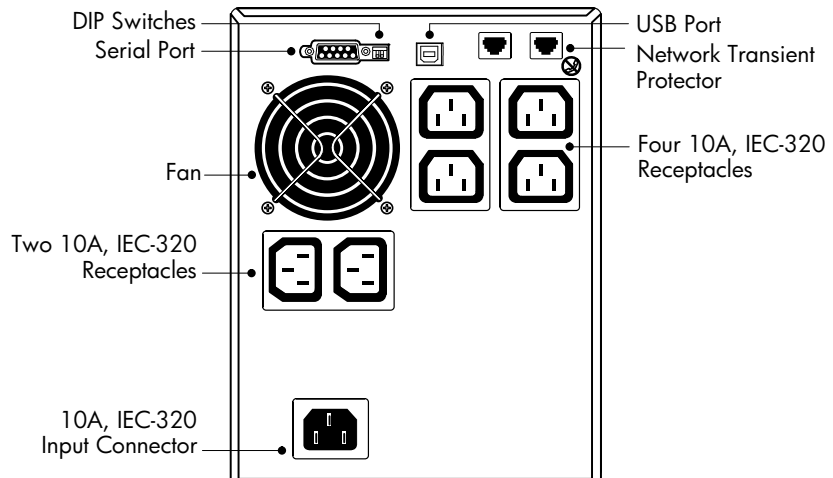

Figure 11 HP T1000 G3, 230V Rear Panel

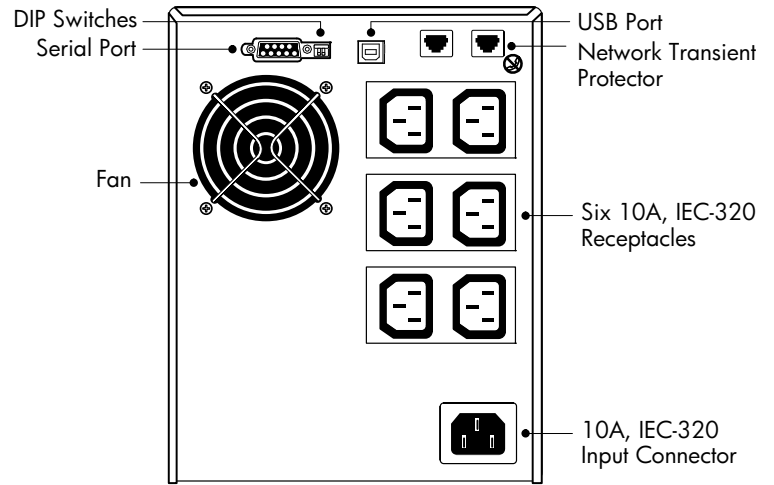

Figure 12 HP T1500 G3, 230V Rear Panel

Chapter 4



Operation

This section describes:

- Turning the UPS on and off
- Starting the UPS on battery
- Standby mode
- The UPS front panel and indicators
- Initiating the self-test

Turning the UPS On

After the UPS is connected to a power outlet, the UPS enters Standby mode.

To turn on the UPS, press and hold the  (On/Off) button until you hear the UPS beep. After the UPS is turned on, it conducts a self-test and enters Normal mode. The  (Power On) indicator illuminates green indicating that power is available to your equipment.

Starting the UPS on Battery

NOTE: The UPS does not auto-detect the input frequency when starting on battery; the default is the last frequency used by the UPS.

To turn on the UPS without using utility power, press and hold the  (On/Off) button for two seconds. The UPS starts up in Battery mode and supplies battery power to your equipment. When the UPS starts on battery, it does not conduct a self-test to conserve battery power.

Turning the UPS Off

NOTE: Pressing the  (On/Off) button while the UPS is in Battery mode causes the UPS to shut down immediately.

To turn off the UPS:

- 1 Shut down the equipment connected to the UPS.
- 2 Press and hold the  (On/Off) button for two seconds. The UPS transfers to Standby mode (if utility power is available) and removes power from your equipment.
- 3 Unplug the UPS from the power outlet.

If you do not unplug the UPS, it remains in Standby mode.

Standby Mode

When the UPS is turned off and remains plugged into a power outlet, the UPS is in Standby mode. All indicators are off, and power is not available to your equipment. The battery recharges when necessary.

NOTE: For 220–240V models, the output receptacles may remain electrically live (up to 110–120V). Unplug the UPS to ensure power is not available to the output receptacles.

UPS Front Panel

The UPS front panel indicates the UPS status and also identifies potential power problems. Figure 13 shows the UPS front panel indicators and controls.

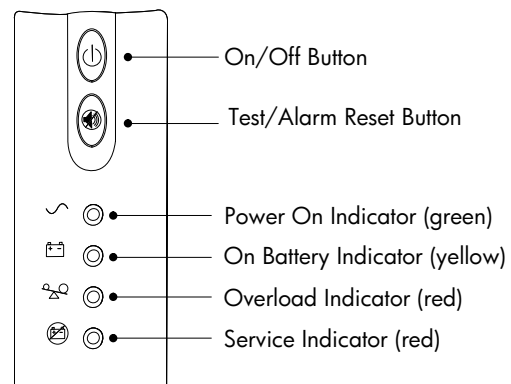



Figure 13 UPS Front Panel

If the UPS beeps or a UPS alarm indicator stays on, see Table 10 on page 28 to identify and correct the problem.

Initiating the Self-Test

NOTE: The batteries must be fully charged and the UPS must not be in Battery mode to perform the self-test.

Press and hold the  (Test/Alarm Reset) button for three seconds to initiate the self-test. During the five-second test, the bar graph indicators cycle through twice. If the UPS beeps or a UPS alarm indicator stays on, see “Troubleshooting” on page 27.

Chapter 5

Additional UPS Features



This section describes:

- Voltage configuration
- USB port and serial port
- Network transient protector
- HP Power Manager software

Voltage Configuration

The DIP switches on the rear panel of each unit (see Figure 14) are used to configure the output voltage and input voltage range.

To configure voltage:

- 1 The UPS must be completely shutdown.
To turn off the UPS, press and hold the  (On/Off) button for two seconds and then unplug the UPS from the power outlet.
- 2 Set the DIP switches according to the configurations in Table 1 on page 14.
- 3 Plug the UPS power cord into a power outlet.
- 4 Press and hold the  (On/Off) button until you hear the UPS beep to turn the UPS on.

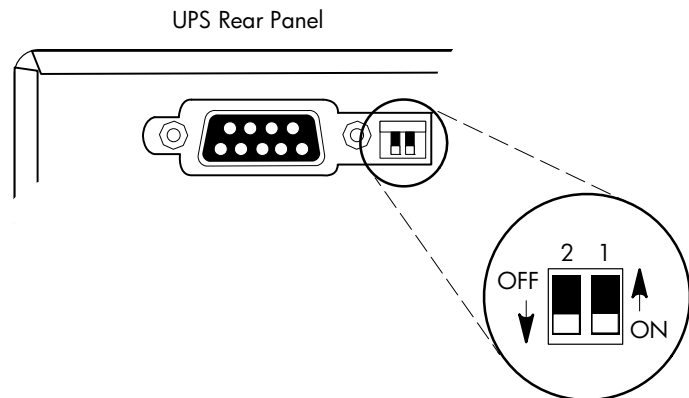

Figure 14 DIP Switches

Table 1 DIP Switch Settings

100V Models			
Output Voltage	Input Voltage Range	DIP Switch 1	DIP Switch 2
100V	90–106V	ON	ON
120V Models			
Output Voltage	Input Voltage Range	DIP Switch 1	DIP Switch 2
110V	99–116V	ON	OFF
120V*	108–127V*	OFF	OFF or ON
230V Models			
Output Voltage	Input Voltage Range	DIP Switch 1	DIP Switch 2
220V	198–233V	ON	OFF
230V*	207–243V*	OFF	OFF or ON
240V	216–254V	ON	ON

* Default position

Communication Options

The UPS is equipped with a USB port and a serial port. Either the USB port or the serial port may be used to monitor the UPS; however, they cannot operate simultaneously.

USB Port

The UPS can communicate with a USB-compliant computer using HP Power Manager software.

To establish communication between the UPS and a computer:

- 1 Connect the USB cable to the USB port on the UPS rear panel.
Connect the other end of the USB cable to the USB port on your computer.

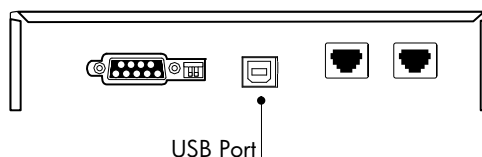

Figure 15 The USB Port

- 2 Install the HP Power Manager software according to the instructions provided with the software.

Serial Port

To establish communication between the UPS and a computer, connect your computer to the UPS serial port using the supplied communication cable.

When the communication cable is installed, HP Power Manager software can exchange data with the UPS. The software polls the UPS for detailed information on the status of the power environment. If a power emergency occurs, the software initiates the saving of all data and an orderly shutdown of the equipment.

The cable pins are identified in Figure 16, and the pin functions are described in Table 2.

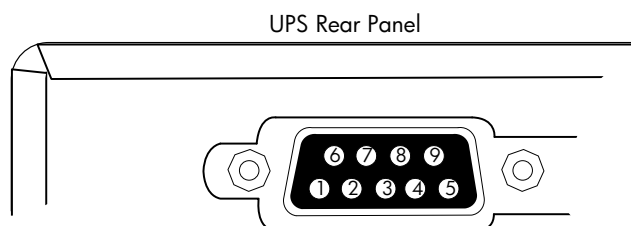

Figure 16 Serial Port

Table 2 Serial Port Pin Assignment

Pin Number	Signal Name	Function	Direction from the UPS
1	Low Batt	Low battery relay contact; 20 mA, 30 Vdc contact rating	Out
2	TxD	Transmit to external device	Out
3	RxD	Receive from external device	In
4	DTR	PnP (Plug and Play) from external device (tied to Pin 6)	In
5	GND	Signal common (tied to chassis)	—
6	DSR	To external device (tied to Pin 4)	Out
7	—	No connection	—
8	AC Fail	AC fail relay contact; 20 mA, 30 Vdc contact rating	Out
9	Power Source	+V (8 to 24 volts DC power)	Out

Network Transient Protector

The network transient protector, shown in Figure 17, is located on the rear panel and has jacks labeled IN and OUT. This feature accommodates a single RJ-45 (10BaseT) network connector.

Low voltage models can also accommodate an RJ-11 telephone connector that provides protection for modems, fax machines, or other telecommunications equipment. As with most modem equipment, it is not advisable to use this jack in digital PBX (Private Branch Exchange) environments.

NOTE: DO NOT connect any telephone or fax/modem equipment (RJ-11) to the 230V models; only connect network cables (RJ-45) to the 230V models.

- 1 Connect the input connector of the equipment you are protecting to the jack labeled IN.
- 2 Connect the network or telephone (low voltage models only) cable to the jack labeled OUT.

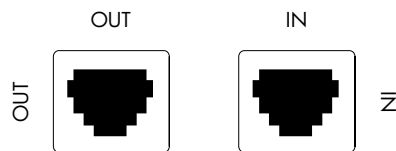

Figure 17 Network Transient Protector

HP Power Manager Software

HP Power Manager software ensures maximum power reliability of computer systems through comprehensive control of UPSs. The easy-to-use browser interface enables novice users to configure and manage power protection settings. To download the latest version of HP Power Manager software, see the HP website (<http://www.hp.com/go/rackandpower>).

NOTE: To install and configure the software, see the software user guide. The software user guide is available for download from the HP website (<http://www.hp.com/go/rackandpower>).

HP Power Manager:

- Does not require complex management systems, which simplifies deployment, configuration, and management of UPS-protected environments.
- Manages a graceful shutdown of attached devices during utility power failures.
- Prioritizes the timing of attached load device shutdowns.
- Shuts down and reboots any UPS and attached load devices based on a user-specified schedule.
- Customizes alert generation with modifiable dialog boxes, command execution, and email and broadcast messages.
- Monitors the status of the UPS and reports alarms.
- Displays a power log for analysis.

Chapter 6

UPS Maintenance

This section explains how to:

- Care for the UPS and batteries
- Transport the UPS
- Store the UPS and batteries
- Order spare batteries
- Replace the batteries
- Test new batteries
- Recycle used batteries or UPS

UPS and Battery Care

For the best preventive maintenance, keep the area around the UPS clean and dust-free. If the atmosphere is very dusty, clean the outside of the system with a vacuum cleaner.

For full battery life, keep the UPS at an ambient temperature of 25°C (77°F).

NOTE: The batteries in the UPS are rated for a 3–5 year service life. The length of service life varies, depending on the frequency of usage and ambient temperature. Batteries used beyond expected service life will often have severely reduced runtimes. Replace batteries at least every 5 years to keep units running at peak efficiency.

Transporting the UPS

NOTE: The internal UPS batteries **MUST** be disconnected during transport.

If the UPS requires any type of transportation:

- 1 Verify that the UPS is unplugged and turned off.
- 2 Pull the top left corner forward and remove the UPS front bezel (see Figure 18).

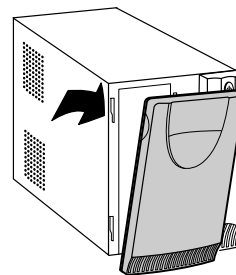

Figure 18 Removing the UPS Front Bezel

- 3 Slide up and remove the metal battery cover (see Figure 19). Do not remove any screws.

NOTE: For HP T750 G2, HP T750J, and HP T1000 G3 models, carefully remove the metal battery cover to avoid damaging the battery disconnect blades.

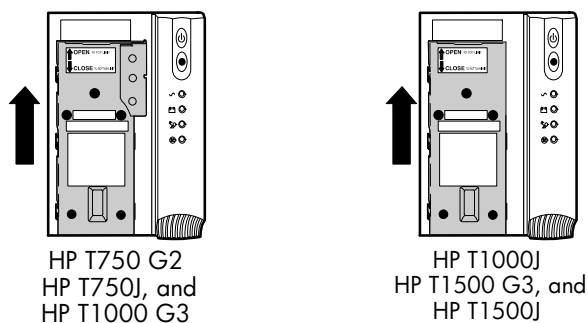

Figure 19 Removing the Battery Cover

- 4 Disconnect the red wire from the positive (+) battery connector (see Figure 20).

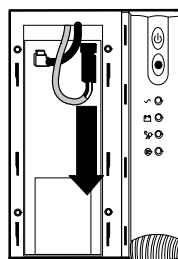

Figure 20 Disconnecting the Internal Battery Connector

- 5 Replace the metal battery cover.
- 6 Replace the UPS front bezel.

Storing the UPS and Batteries

If you store the UPS for a long period, recharge the battery every 6 months by plugging the UPS into a power outlet. The batteries charge to 90% capacity in approximately 3 hours. However, to fully charge, HP recommends that the batteries charge for 6 to 24 hours after long-term storage.

Check the battery recharge date on the shipping carton label. If the date has passed and the battery was never recharged, do not use the UPS. Contact your service representative.

UPS Battery Spares

Ordering Spares

To order a spare, visit the HP website (<http://h61003.www6.hp.com>).

To replace parts under warranty, contact an HP authorized service representative.

UPS Spare Parts List

Description	Spare part number
T750G2 UPS battery module	502538-001
T750J, T1000G3 UPS battery module	502539-001
T1000J, T1500J, T1500G3 UPS battery module	502540-001
T750G2 UPS unit NA	502532-001
T750G2 UPS unit INTL	502533-001
T750J UPS unit JPN	538256-001
T1000G3 UPS unit NA	502534-001
T1000G3 UPS unit INTL	502535-001
T1000J UPS unit JPN	538257-001
T1500 UPS unit NA	502536-001
T1500 UPS unit INTL	502537-001
T1500J UPS unit JPN	538258-001

Replacing Batteries

NOTE: DO NOT DISCONNECT the batteries while the UPS is in Battery mode.

With the hot-swappable battery feature, batteries can be replaced easily without turning the UPS off or disconnecting the load.

If you prefer to remove input power to change the batteries, press and hold the  (On/Off) button for two seconds and then unplug the UPS.

Consider all warnings, cautions, and notes before replacing batteries.



WARNING

- Batteries can present a risk of electrical shock or burn from high short circuit current. The following precautions should be observed: 1) Remove watches, rings, or other metal objects; 2) Use tools with insulated handles; 3) Do not lay tools or metal parts on top of batteries.
 - **ELECTRIC ENERGY HAZARD.** Do not attempt to alter any battery wiring or connectors. Attempting to alter wiring can cause injury.
 - Replace batteries with the same number and type of batteries as originally installed in the UPS.
-



CAUTION

Pull the battery out onto a flat, stable surface. The battery is unsupported when you pull it out of the UPS.

To replace the UPS internal battery:

- 1 Pull the top left corner forward and remove the UPS front bezel (see Figure 21).

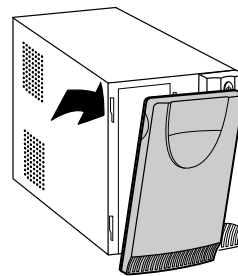

Figure 21 Removing the UPS Front Bezel

- Slide up and remove the metal battery cover (see Figure 22). Do not remove any screws.

NOTE: For HP T750 G2, HP T750J, and HP T1000 G3 models, carefully remove the metal battery cover to avoid damaging the battery disconnect blades.

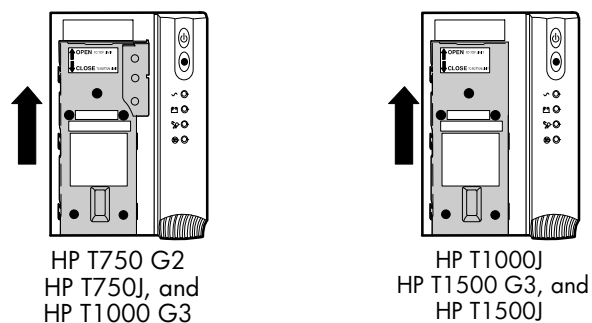

Figure 22 Removing the Battery Cover

For HP T750 G2, HP T750J, and HP T1000 G3 models, see Figure 23. For HP T1000J, HP T1500J, and HP T1500 G3 models, see Figure 24:

- Disconnect the red battery cable.
- Pull the battery out onto a flat, stable surface.

For HP T1000J, HP T1500 G3, and HP T1500J, slowly pull the battery out just far enough to expose the cable retainer for the black battery lead and carefully remove the battery lead from the cable retainer.

- Carefully disconnect the black battery cable to the UPS.

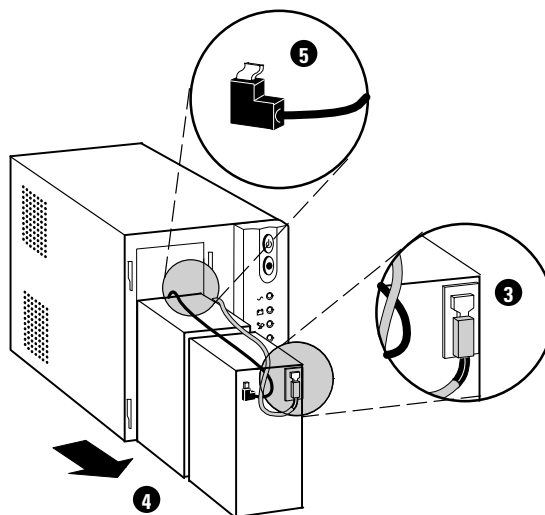

Figure 23 Removing the Battery (HP T750 G2, HP T750J and HP T1000 G3 Models)

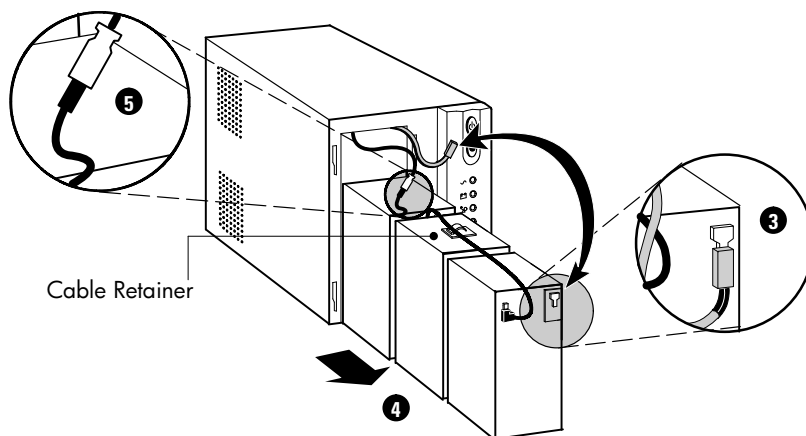

Figure 24 Removing the Battery (HP T1000J, HP T1500J, HP T1500 G3 Models)

- 6 Replace the battery. See “Recycling the Used Battery or UPS” on page 23 for proper disposal.
- 7 Place the new battery pack in the same position with the battery terminals at the top.
- 8 Connect the black battery cable to the new battery.
- 9 Slide the batteries into the UPS. For HP T1000J, HP T1500 G3, and HP T1500J, carefully replace the black battery cable into the cable retainer.

CAUTION



To avoid damage to the battery leads, be sure that the cables do not bind against the guide rail while reinstalling the battery.

- 10 Connect the red battery cable.

NOTE: A small amount of arcing may occur when connecting the batteries. This is normal and does not damage the unit or present any safety concern.

- 11 Replace the metal battery cover and UPS front bezel.

Testing New Batteries

NOTE: Allow batteries to charge for 6 to 24 hours before testing.

NOTE: The batteries must be fully charged and the UPS must not be in Battery mode to perform the self-test.

Press and hold the (Test/Alarm Reset) button for three seconds to initiate a self-test. The 15-second test automatically distributes the load to the battery and tests the battery's performance. While the test is in progress, the indicators cycle through and the UPS beeps. When complete, the UPS returns to Normal mode as indicated by the (Power On) indicator.

If there is a problem with the battery, the UPS beeps, the (On Battery) indicator illuminates and the (Service) indicator flashes. Check the battery connections and be sure the battery is fully charged. Call your service representative if the problem persists.

Recycling the Used Battery or UPS

Contact your local recycling or hazardous waste center for information on proper disposal of the used battery or UPS.



WARNING

- Do not dispose of the battery or batteries in a fire. Batteries may explode. Proper disposal of batteries is required. Refer to your local codes for disposal requirements.
- Do not open or mutilate the battery or batteries. Released electrolyte is harmful to the skin and eyes. It may be toxic.



CAUTION

Do not discard the UPS or the UPS batteries in the trash. This product contains sealed, lead-acid batteries and must be disposed of properly. For more information, contact your local recycling/reuse or hazardous waste center.



CAUTION

Do not discard waste electrical or electronic equipment (WEEE) in the trash. For proper disposal, contact your local recycling/reuse or hazardous waste center.

Chapter 7

Specifications

This section provides the following specifications:

- Model list
- Dimensions and weights
- Electrical input and output
- Environmental and safety
- Battery

Table 3 Model List

	100V Models	120V Models	230V Models
UPS Models	HP T750J (HSTNR-U017-N) HP T1000J (HSTNR-U018-N) HP T1500J (HSTNR-U018-J)	HP T750 G2 (HSTNR-U016-N) HP T1000 G3 (HSTNR-U017-N) HP T1500 G3 (HSTNR-U018-N)	HP T750 G2 (HSTNR-U016-I) HP T1000 G3 (HSTNR-U017-I) HP T1500 G3 (HSTNR-U018-I)

Table 4 Dimensions and Weights

	100V Models	120V Models	230V Models
UPS Dimensions (W × H × D)	HP T750 G2, HP T750J, and HP T1000 G3: 15.0 × 19.3 × 33.5 cm (5.9" × 7.6" × 13.2") HP T1000J, HP T1500 G3, and HP T1500J: 15.0 × 19.3 × 39.0 cm (5.9" × 7.6" × 15.4")		
UPS Weights	HP T750 G2: 12.4 kg (27.3 lb) HP T750J and HP T1000 G3: 12.6 kg (27.8 lb) HP T1000J and HP T1500 G3: 16.8 kg (37.0 lb) HP T1500J: 17.2 kg (37.9 lb)		

Table 5 Electrical Input

	100V Models	120V Models	230V Models
Nominal Voltage	100V	110V, 120V selectable	220V, 230V, 240V selectable
Voltage Range	±20% for nominal voltage at full load		
Nominal Frequency	45–65 Hz, 50/60 Hz auto-sensing		
Efficiency (Normal mode)	95%		
Noise Filtering	Full-time EMI/RFI filtering		
Overcurrent Protection	Resettable input overcurrent protector	N/A	
Connections	6-ft, 5-15P power cord (90° angle)	10A, IEC-320 input connector	

Table 6 Electrical Output

	100V Models	120V Models	230V Models
Power Levels (rated at nominal inputs)	100V: 750 VA, 500W 1000 VA, 680W 1200 VA, 980W	110V and 120V: 750 VA, 500W 1000 VA, 670W 120V: 1400 VA, 950W	750 VA, 500W 1000 VA, 670W 1400 VA, 950W
Power Factor	0.67		
Regulation (Normal mode)	-10% to +6% of nominal voltage		
Regulation (Battery mode), Nominal Voltage $\pm 5\%$	Same as selected nominal input voltage 100V	Same as selected nominal input voltage 110V, 120V	Same as selected nominal input voltage 220V, 230V, 240V
Voltage Waveform	Sine wave		
Overcurrent Protection	Inverter saturation current limited		
Output Receptacles	HP T750J, HP T1000J, and HP T1500J: (6) 5-15	HP T750 G2: (4) 5-15 HP T1000 G3 and HP T1500 G3: (6) 5-15	HP T750 G2: (4) 10A, IEC-320 HP T1000 G3 and HP T1500 G3: (6) 10A, IEC-320

Table 7 Environmental and Safety

	100/120V Models	230V Models
Operating Temperature	Up to 1,500 meters: 0°C to 40°C (32°F to 104°F); UL tested 25°C (77°F) Above 1,500 meters: 0°C to 35°C (32°F to 95°F)	
Transit/Storage Temperature	-15°C to 55°C (5°F to 131°F)	
Relative Humidity	5–95% noncondensing	
Operating Altitude	Up to 3,000 meters above sea level	
Audible Noise	Less than 45 dBA typical	
Surge Suppression	ANSI C62.41 Category A (formerly IEEE 587)	
Safety Conformance	UL 1778 2nd Edition; UL 497A; CSA C22.2, No. 107.1	IEC/EN 62040-1-1 and IEC/EN 60950-1
Safety Markings	cULus, cUL, NOM-NYCE	CE, TÜV, C-Tick, GOST R, EK, IRAM, TISI
EMC (Class B)	FCC Part 15, ICES-003, VCCI	IEC/EN 62040-2, FCC Part 15, ICES-003, VCCI

Table 8 Battery

UPS Configuration	HP T750 G2: (2) 12V, 7 or 7.2 Ah internal batteries HP T750J and HP T1000 G3: (2) 12V, 9 Ah internal batteries HP T1000J, HP T1500 G3, and HP T1500J: (3) 12V, 9 Ah internal batteries
Voltage	HP T750 G2, HP T750J, and HP T1000 G3: 24 Vdc HP T1000J, HP T1500 G3, and HP T1500J: 36 Vdc
Type	Sealed, maintenance-free, valve-regulated, lead-acid
Charging	Advanced charging for faster recovery; approximately 3 hours to 90% usable capacity at nominal line and no supplementary power supply load
Monitoring	Advanced monitoring for earlier failure detection and warning

Table 9 Battery Runtimes (in Minutes)

Load (VA)	Watts	UPS Models by VA Ratings		
		750	1000	1400
200	128	38	41	58
300	192	27	28	41
500	320	14	15	28
600	402	9	10	19
750	503	6	8	14
900	603		6	10
1000	670		5	8
1200	804			6
1400	938			5

NOTE Battery times are approximate and may vary depending on the load configuration and battery charge.

Chapter 8

Troubleshooting

This section explains:

- UPS alarms and conditions
- How to silence an alarm
- Site wiring fault (100–120V models only)
- Service and support

Audible Alarms and UPS Conditions

The UPS has an audible alarm feature to alert you of potential power problems. Use Table 10 to determine and resolve the UPS alarms and conditions.

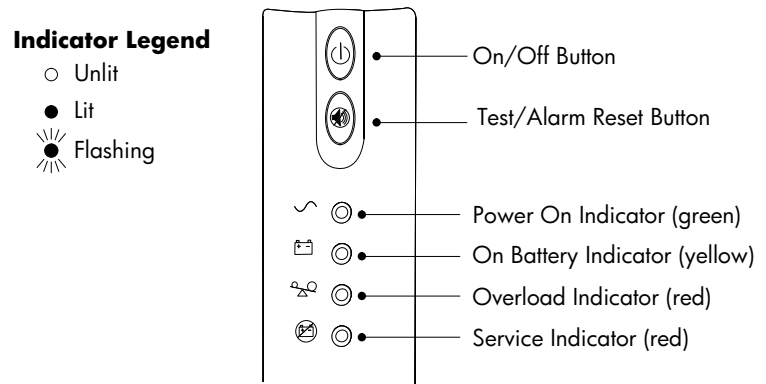



Figure 25 UPS Front Panel

Silencing an Audible Alarm

Before silencing an alarm, check the alarm condition and perform the applicable action to resolve the condition (see Table 10).

To silence the alarm for an existing fault, press the  (Test/Alarm Reset) button. If UPS status changes, the UPS beeps, overriding the previous alarm silencing.

The alarm does not silence if there is a UPS fault, low battery condition, or if the battery needs to be replaced.

Site Wiring Fault (100–120V Models Only)

The Site Wiring Fault indicator on the UPS rear panel illuminates if the ground wire connection does not exist or the line and neutral wires are reversed in the line receptacle. This indicator stays on until the condition is resolved. Have a qualified electrician correct the wiring fault. The UPS operates when the indicator is illuminated, but does not provide rated noise and surge suppression.

Table 10 Troubleshooting Guide

































Alarm or Condition	Possible Cause	Action
The  indicator is not on; the UPS does not start.	The power cord is not connected correctly.	Check the power cord connections.
	The UPS is in Standby mode.	Press and hold the  (On/Off) button until you hear the UPS beep to supply power to the connected equipment.
	The wall outlet is faulty.	Have a qualified electrician test and repair the outlet.
The UPS operates in Battery mode only, even though normal utility power is present.	The input overcurrent protector is open (100–120V models only).	Save your work and turn off your equipment. Turn off the UPS. Reduce the load, then press the input overcurrent protector on the UPS rear panel.
The UPS does not provide the expected backup time.	The batteries need charging or service.	Plug the UPS into a power outlet for 24 hours to charge the battery. Press the  (Test/Alarm Reset) button. If the UPS beeps, see “Replacing Batteries” on page 20 to replace the battery. During an extended power outage, save your work and turn off your equipment to conserve battery power.
 ●	Normal operation.	None. The UPS is operating in Normal mode and automatically provides consistent voltage with the Buck and Boost feature.
 ● 1 beep every 4 seconds.	The UPS is on battery due to a utility failure.	The UPS is powering your equipment with battery power. Prepare your equipment for shutdown. During an extended power outage, save your work and turn off your equipment to conserve battery power.
 1 beep every 2 seconds.	The battery is running low.	Two minutes or less of battery power remains depending on load configuration and battery charge. Save your work and turn off your equipment. The alarm cannot be silenced.
 ● 1 beep every 4 seconds.	The UPS is running on battery power because the input voltage is too high or too low.	Correct the input voltage, if possible. The UPS continues to operate on battery until the condition is corrected or the battery is completely discharged. If the condition persists, the input voltage in your area may differ from the UPS nominal. Change the UPS input voltage to match your local voltage (see “Voltage Configuration” on page 13).
 ● 1 beep per second.  ●	Power requirements exceed UPS capacity (overload is greater than 120%) or the load is defective.	The UPS will automatically shut down in 3 minutes. Save your work immediately and turn off your equipment. Turn off the UPS. Remove some of the equipment from the UPS. You may need to obtain a larger capacity UPS.
 ● 1 beep per second.  ●	The UPS is on battery, and the power requirements exceed UPS capacity (overload is greater than 120%) or the load is defective.	Shutdown is imminent (30 seconds). Save your work and turn off your equipment. Turn off and unplug the UPS. Remove some of the equipment from the UPS. Wait at least 5 seconds until all LEDs are off, and then restart the UPS. You may need to obtain a larger capacity UPS.
 ● Continuous beep. 	Battery test failed.	Check the battery connections and be sure the battery is fully charged. If the  (Service) indicator still flashes, see “Replacing Batteries” on page 20. Call your service representative if the problem persists.

Table 10 Troubleshooting Guide (continued)

Alarm or Condition	Possible Cause	Action
 ● Continuous beep.  ●  ●	UPS internal temperature is too high.	Shutdown is imminent. Save your work and turn off your equipment. Turn off the UPS. Clear vents and remove any heat sources. Ensure the airflow around the UPS is not restricted. Wait at least 5 minutes and restart the UPS. If the condition persists, contact your service representative.
 ● Continuous beep.  ●	UPS fan fault.	Save your work and turn off your equipment. Turn off the UPS. Contact your service representative.
 ● 3 beeps every 10 seconds.  ●  ●  ●  ●	Failed attempt to start the UPS on battery.	Plug the UPS into a power outlet for 24 hours to charge the battery. After charging the battery, press and hold the  (Test/Alarm Reset) button for 3 seconds, and then check the  (Service) indicator. If the  (Service) indicator still flashes, see “Replacing Batteries” on page 20.
 ● Continuous beep.  ●  ●	The output wave is abnormal while the UPS is on battery.	Shutdown is imminent. Save your work and turn off your equipment. Turn off the UPS. Contact your service representative.
 ● Continuous beep.  ●	The output voltage is below or above the limit while the UPS is on battery.	Save your work and turn off your equipment. Turn off the UPS. Contact your service representative.

Technical Support

Before You Contact HP

Be sure to have the following information available before you call HP:

- Technical support registration number (if applicable)
- Product serial number
- Product model name and number
- Product identification number
- Applicable error messages
- Add-on boards or hardware
- Third-party hardware or software
- Operating system type and revision level

HP Contact Information

For the name of the nearest HP authorized reseller:

- In the United States, see the HP US service locator webpage (http://www.hp.com/service_locator).
- In other locations, see the Contact HP worldwide (in English) webpage (<http://welcome.hp.com/country/us/en/wwcontact.html>).

For HP technical support:

- In the United States, for contact options see the Contact HP United States webpage (http://welcome.hp.com/country/us/en/contact_us.html). To contact HP by phone:
 - Call 1-800-HP-INVENT (1-800-474-6836). This service is available 24 hours a day, 7 days a week. For continuous quality improvement, calls may be recorded or monitored.
 - If you have purchased a Care Pack (service upgrade), call 1-800-633-3600. For more information about Care Packs, refer to the HP website (<http://www.hp.com/hps>).
- In other locations, see the Contact HP worldwide (in English) webpage (<http://welcome.hp.com/country/us/en/wwcontact.html>).

Chapter 9

Warranty Information

Limited Warranty

To back up the wide range of features offered with the UPS, a 3-year limited warranty is provided.

\$250,000 Computer Load Protection Guarantee

In addition to the limited warranty, a \$250,000 Computer Load Protection Guarantee (provided by the original equipment manufacturer) is offered.

IMPORTANT: The \$250,000 Computer Load Protection Guarantee is offered only in The United States and Canada.

The \$250,000 Computer Load Protection Guarantee only applies if:

- The UPS is plugged into a suitably grounded and wired outlet using no extension cords, adapters, other ground wires, or other electrical connections.
- The UPS installation complies with all applicable electrical and safety codes specified by the NEC.
- The UPS is used under normal operating conditions and users comply with all instructions and labels.
- The UPS is not damaged by accident (other than a utility power transient), misuse, or abuse.
 - The Guarantee applies only to the original end-user and is non-transferable.
 - The Guarantee does not include reimbursement for or restoration of any data loss.
- The UPS is either connected directly to an enterprise class PDU, which is then connected directly to a server, workstation, or personal computer, or the UPS is connected directly to a server, workstation, or personal computer.

Pre-Failure Battery Warranty

The Pre-Failure Battery Warranty, standard on all UPS units, extends the advantage of a 3-year limited warranty by applying it to the battery before it actually fails. The Pre-Failure Battery Warranty ensures that the battery is replaced free of charge when a notification that the battery might fail is received from power management software. The battery warranty coverage is 3 years for parts. The warranty for the first year of ownership includes parts and labor. If battery spares are not available for a particular UPS model, the entire UPS, including its battery, is replaced.

A Pre-Failure Battery warning is given 30 days before a battery failure. The warning is indicated in one or both of the following ways:

- An LED showing the battery is low
- Notification from power management software